

SILVERLINE LEAN - TO

86, 106, 126

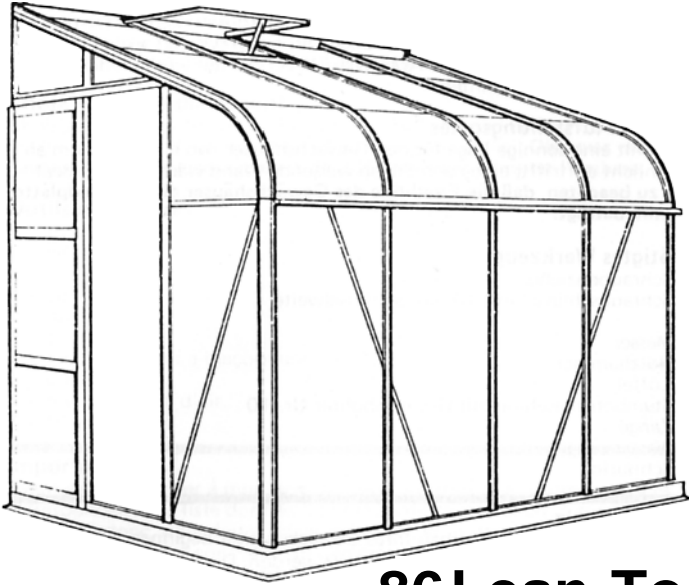

86 Lean-To

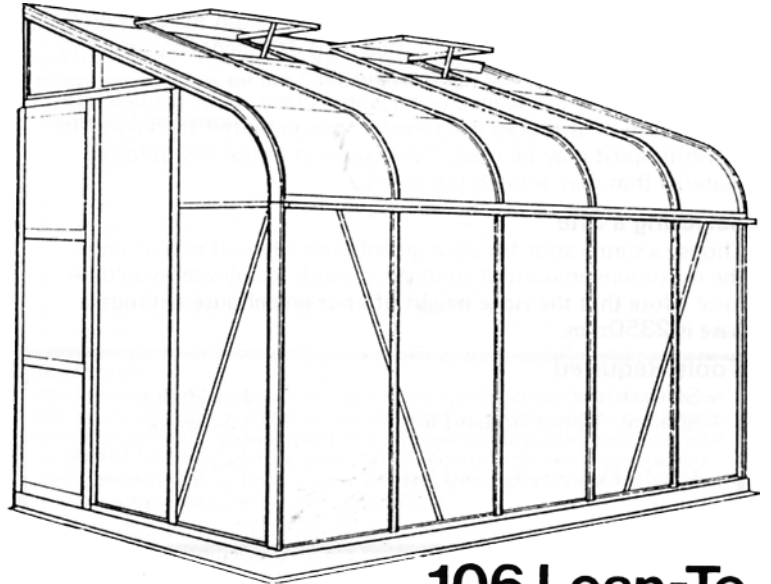

106 Lean-To

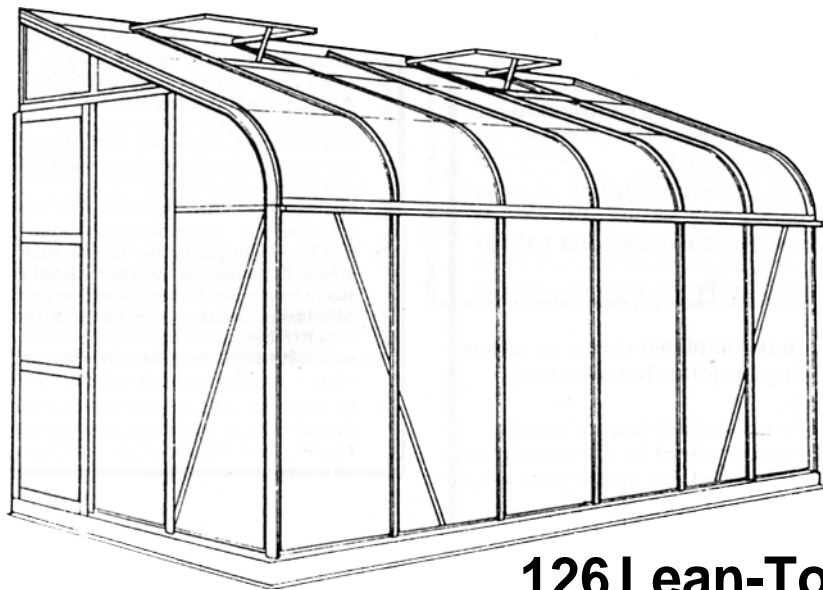

126 Lean-To



www.hallsgreenhouses.com

Please refer to website for the most up to date instructions.

Introduction

You now own a greenhouse that is believed to be amongst the best in value on the market, and by carefully following these assembly instructions, it will give you years of trouble-free use. We hope you will find the following hints and explanations useful.

Your greenhouse is made of aluminium because it is the best all-round material within the price limits the average householder can afford. It will not swell, shrink, warp or rust. In service, it should become a dull whitish-grey colour, sometimes with a slightly rough surface on the outside which forms a self-protecting layer.

If you have the horticultural glass, the small panes are less likely to crack due to movement of the greenhouse, are easier to transport and cheaper to replace in the event of accidental damage.

The acrylic sheet has been selected for its flexibility to form the curved part of the roof, its weather resistance and lasting clarity.

We recommend that you give your greenhouse all round protection by including it in your house insurance.

Maintenance

To keep your greenhouse clean, occasionally wash the glass and aluminium frame thoroughly with a mild detergent solution. For difficult stains, white spirit may be used.

The acrylic may be cleaned using warm soapy water applied with a soft cloth. If this does not remove foreign matter then paraffin or white spirit may be used. Take care not to use any abrasive material that may scratch the acrylic.

Selecting a Site

Choose a sunny spot for your greenhouse where it will receive a fair amount of sunlight.

Note that the ridge height of your greenhouse without the base is 2350mm.

















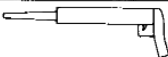
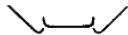







Tools Required



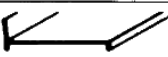
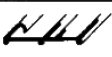

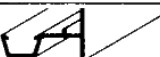

1 – Screwdriver	1 – Spoon
1 – Spanner 10mm Across Flats	1 – Pair of Pliers
1 – No. 10 Masonry Bit and Drill	1 – Spirit Level
1 – Knife	

Important

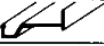
Before starting the assembly of your greenhouse, please check all the contents against the parts list. The parts for each section are bundled together, so to avoid mixing them up, open each bundle separately. If anything is missing, please contact Customer Service Dept., using the reply form included in these instructions.

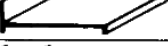
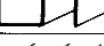
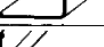
1. Carefully read these instructions before unpacking and do not start to assemble until you fully understand them.
2. Assistance will be necessary during assembly.
3. Considerable care should be taken in the preparation of a level and square base.
4. Before fixing frame to base, check for squareness and tighten all nuts and bolts. Weatherseal the join between frame and base, frame and house and all other corner joints.
5. Glazing should not be hurried, but completed in one go, giving great care and attention to sealing the joints between roof and panes with the sealant provided.
6. To minimise the condensation, we recommend that your greenhouse is well ventilated. This can be achieved by the installation of a louvre vent. A louvre vent can only be fitted in the 106 and the 126 models.
7. It is recommended that a snow guard be fitted to the house gutter above the greenhouse if there is a risk of falling debris damaging the greenhouse.

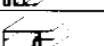
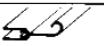
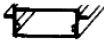
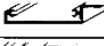
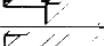
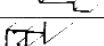
Code No.	Item	Quantity			Length mm	DEUTSCH	FRANCAIS
		86	106	126			
400	 Aluminium nuts and bolts	78	85	92	—	Alu-Muttern und Schrauben	Ecrous et boulons aluminium
1106	 No. 6 x 16mm self-tapping screws	16	20	20	—	Blechschräuben No 6 x 16mm	Vis auto-taraudeuses No 6 x 16mm
229	 No. 6 x 10mm self-tapping screws	4	8	8	—	Blechschräuben 10mm x No. 6	Vis auto-taraudeuses No. 6 x 10mm
996	 M3-8 pan head screws and nuts	4	4	4	—	8 M3-Kegelkopfschrauben mit Muttern	Vis à tête cylindrique M3-8 avec écrous
997	 M3-25 countersunk head screws and nuts	2	2	2	—	25 M3-Senkkopfschrauben und Muttern	Vis M3-25 à tête fraisée et écrous
478	 Door bottom bar slides	2	2	2	—	Gleitvorrichtung für unteres Türprofil	Coulisseau de bas de porte
37	 Silicon sealant and gun	1	1	1	—	Silikon-Dichmittel und Pistole	Produit d'étanchéité au silicone et pistolet
453	 Glazing spring clips	218	250	282	—	Verglasungsfederklammern	Clips à ressort de vitrage
458	 Glazing retaining clips	50	54	58	—	Glashalteklammern	Clips de retenue de vitrage
452	 Glazing retaining 'H'	13	15	18	610	H-Profil für Scheibhalterung	H de retenue de vitrage
410	 Glazing strip	1	1	1	61m	Verglasungsstreifen	Baguette de vitrage
410		69m			Verglasungsstreifen	Baguette de vitrage	
410		77m			Verglasungsstreifen	Baguette de vitrage	
142	 Roof vent glazing seal	1	2	2	2500	Dachlüfter-Verglasungsdichtung	Joint d'étanchéité de vitrage de fenêtre
984	 Door seal	2	2	2	2040	Türdichtung	Joint d'étanchéité de porte
991	 Door glazing cap	2	2	2	2006	Türverglasungskappe	Couronnement de vitrage de porte
976	 Door lock	1	1	1	—	Türschloß	Serrure de porte
983	 Roof vent stay	1	2	2	—	Fensteraufsteller	Support de fenêtre
992	 Flush door pull	2	2	2	—	Bündiger Türknopt	Poignée de porte encastrée
428	 Self adhesive foam tape	11	13	15	620	Selbstklebendes Schaumband	Galon mousse autocollant
205	 Corner plates	2	2	2	42	Eckbleche	Plaques cornières
990	 Double sided adhesive foam tape	1	1	1	5000	Schaumstreifen mit doppelseitigem Kleber	Bande de mousse adhésive à double face
701	 Sill bar side	1	1	1	2479	Grundprofil, Seite	Barres de seuil, côté
01		3101			Grundprofil, Seite	Barres de seuil, côté	
33		3723			Grundprofil, Seite	Barres de seuil, côté	
842	 Ridge bar	1	1	1	2479	Dachfirstprofil	Barre en faîteau
372		3101			Dachfirstprofil	Barre en faîteau	
07		3723			Dachfirstprofil	Barre en faîteau	
844	 Roof brace longitudinal	1	1	1	2444	Längsstrebe des Daches	Renfort de toit longitudinal
365		3066			Längsstrebe des Daches	Renfort de toit longitudinal	
11		3688			Längsstrebe des Daches	Renfort de toit longitudinal	
194	 Diagonal side strut	2	2	2	1476	Diagonale Seitenstreben	Entretoises diagonales, côté
329		3	3	3	612	Horizontalstreben Turende	Entretoises horizontales d'extrémité de porte
363	 Door end diagonal strut	1	1	1	1774.5	Diagonalstreben, Turende	Etrésillons diagonaux côté porte
471		2	2	2	1839	Horizontalstreben, Giebelende ohne Tür	Entretoises horizontales d'extrémité simple
201	 Intermediate vertical bar	3	4	5	1348	Senkrechte Zwischenprofile	Barres verticales intermédiaires
346		1	1	1	1882	Senkrechtprofil Turende	Barre verticale, côté porte
359		2	2	2	1878	Senkrechtprofil, Turende	Barre verticale, côté porte
360		1	1	1	190	Senkrechtprofil, Turende	Barre verticale, côté porte
366		1	1	1	2074	Senkrechtprofil, Giebelende ohne Tür	Barre verticale, côté pignon
368		3	4	5	—	Dachzwischenprofile	Barres intermédiaires de toit
843		 Eaves Bar	1	1	1	2479	Dachrinnenprofil
353	3101		Dachrinnenprofil			Barre gouttière	
340	3723		Dachrinnenprofil			Barre gouttière	
361	 Vertical wall bar, left hand	1	1	1	2273	Vertikales Wandprofil (Links)	Barre murale verticale (gauche)
362		1	1	1	2273	Vertikales Wandprofil (Rechts)	Barre murale verticale (droit)
364	 Corner post	2	2	2	1348	Eckpfosten	Montants de coin
369		1	1	1	—	Giebelendstabe (Links)	Barres de pignon (gauche)
370		1	1	1	—	Giebelendstabe (Rechts)	Barres de pignon (droit)

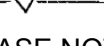
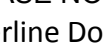
Code No.	Item	Quantity			Length mm	DEUTSCH	FRANCAIS
		86	106	126			
750	 Door track sill	1	1	1	1866	Türschienenschwelle	Seuil à glissière de porte
751	 Vertical door bar, left hand Vertical door bar, right hand	1	1	1	1842	Senkrechte Türprofile (Links)	Barre de porte verticale (gauche)
752		1	1	1	1842	Senkrechte Türprofile (Rechts)	Barre de porte verticale (droit)
756	 Sill bar end	1	1	1	1866	Grundprofil, Ende	Barre de seuil, extrémité
757	 Door jamb	1	1	1	1880	Türpfosten	Montant de porte
758	 Vertical door bar stiffener	1	1	1	1880	Vertikale Türversteifung	Raidisseur de barre verticale de porte
759	 Roof stiffener	3	4	5	1633	Dachzwischenversteifung	Raidisseur intermédiaire de toit
896	 Roof vent side bar, left hand Roof vent side bar, right hand	1	2	2	663	Fensterseitenprofile (Links)	Barres latérales de fenêtre (gauche)
897		1	2	2	663	Fensterseitenprofile (Rechts)	Barres latérales de fenêtre (droit)
913	 Roof vent sill	1	2	2	638	Dachfensterschwelle	Seuil de fenêtre
915	 Roof vent bottom bar	1	2	2	600	Unteres Fensterprofil	Barre inférieure de fenêtre
981	 Roof vent bar	1	2	2	600	Oberes Fensterprofil	Barre supérieure de fenêtre
986	 Intermediate door bar	1	1	1	638	Türzwischenprofile	Barres intermédiaires de porte
987	 Top door bar	1	1	1	638	Oberes Türprofil	Barre supérieure de porte
988	 Bottom door bar	1	1	1	638	Unteres Türprofil	Barre inférieure de porte
989	 Wheel housing	1	1	1	640	Radgehäuse	Élément à roulettes
974	 Door track	1	1	1	1259	Türschiene	Glissière de porte
789	 Door track end	1	1	1		Türansschläge	Butées de porte

PLEASE NOTE PART 00649 IS A REDUNDANT ITEM THAT IS NO LONGER REQUIRED

Silverline Downpipe Kit

N.B. NUT COVERS ARE ONLY SUPPLIED WITH GREEN COATED

MODELS

1

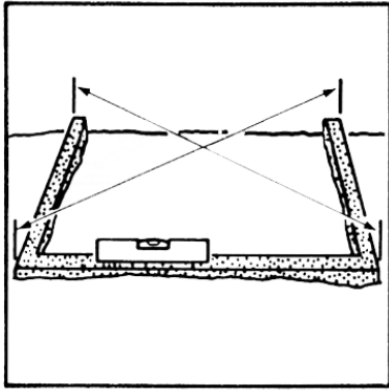

fig 1

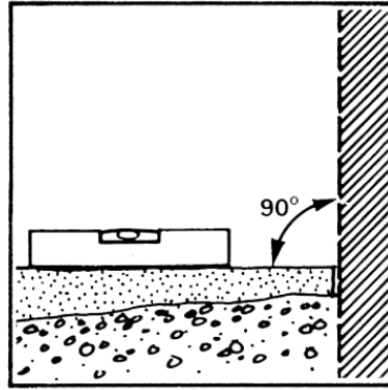

fig 2

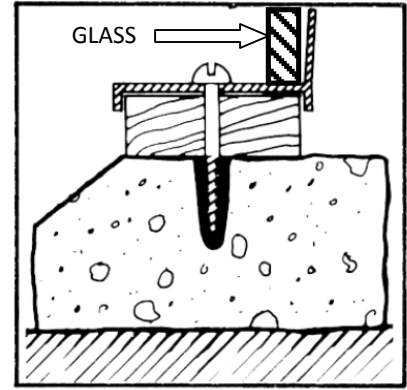

fig 2a

N.B. These diagrams are only if you are building your own base as opposed to buying the prefabricated optional base, which is the easiest option.

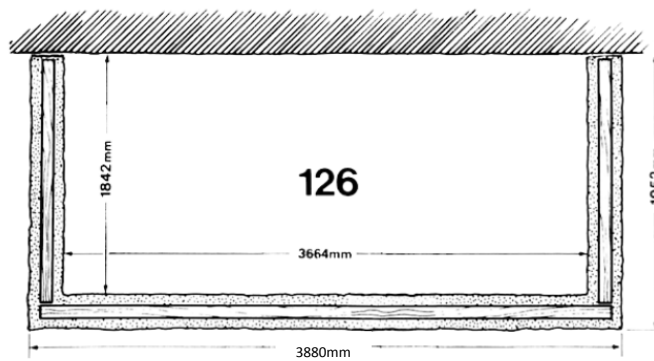
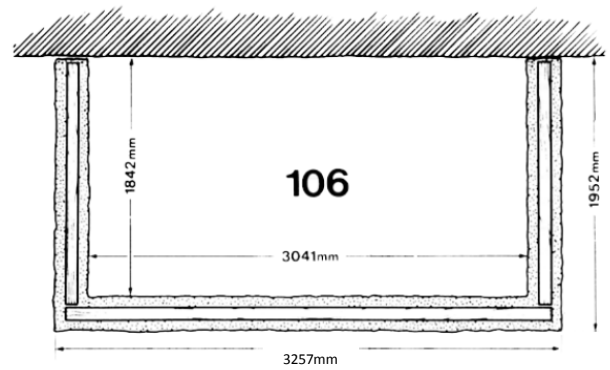
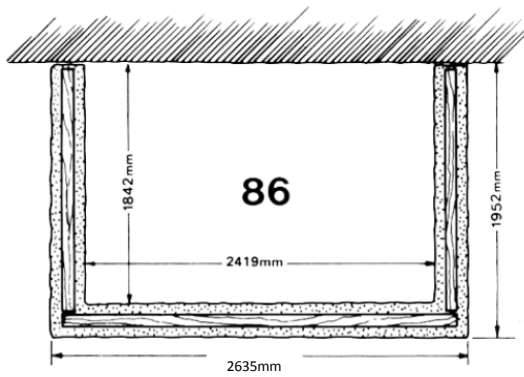

fig 3

Base

You need a base for your greenhouse to ensure that it is level and rigid. To save time and trouble in laying a traditional brick or concrete base, Halls can supply a simple-to-assemble prefabricated base as an optional extra.

However, if you want to make your own base you should make it to the dimensions in fig. 3. It is most important that the base is square and level so check that its diagonal measurements are equal as in fig. 1 and that the angle between the wall and the base is 90° as in fig. 2. Tanalised timber packing of not less than 12mm thickness and not more than 30mm width should be made to fit the aluminium section, as shown in fig. 2a. When the greenhouse has been assembled, it can be screwed to the base with no. 12 screws and rawlbolts (not supplied) through the sill bar (not pre-drilled) in fig. 2a.

IMPORTANT

If you wish to erect your greenhouse on a solid concrete plinth, you should follow the outside dimensions in fig. 3. However it is important to avoid any possibility of water seeping under the base forming puddles. You should ensure that the base slopes down towards the outside of the greenhouse. The timber packing will have to be suitably tapered.

2

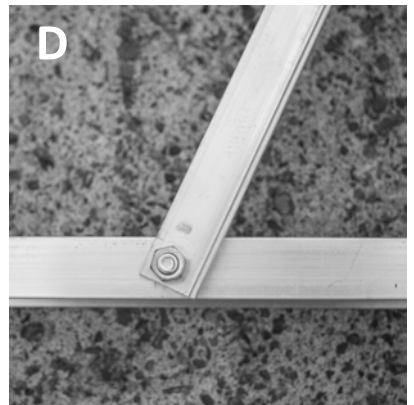
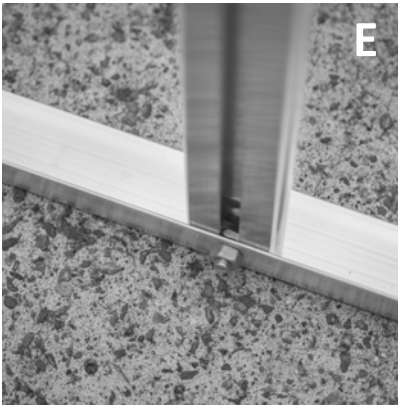
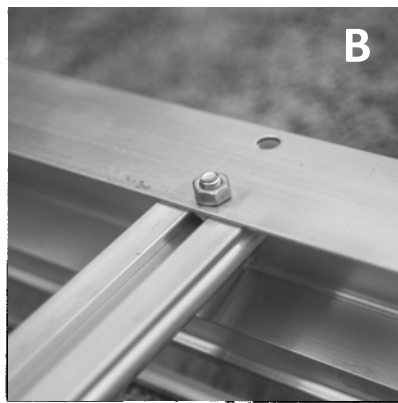
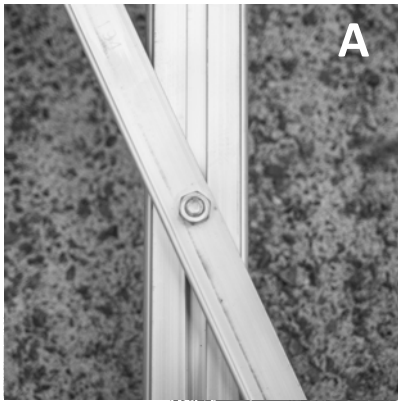

PLEASE NOTE THE GREENHOUSE MAY BE SUPPLIED WITH EITHER SQUARE NUTS OR HEXAGONAL NUTS.

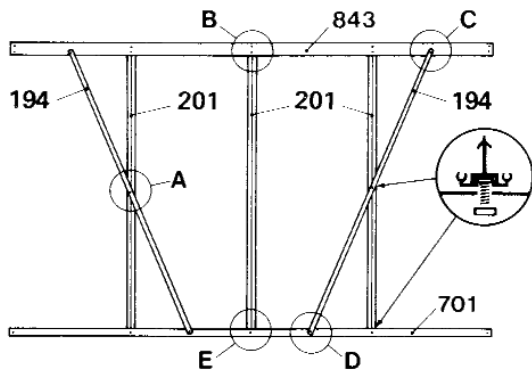

fig 4

86

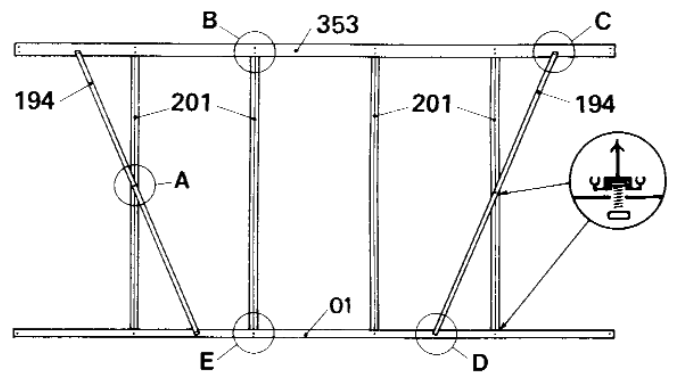

fig 4

106

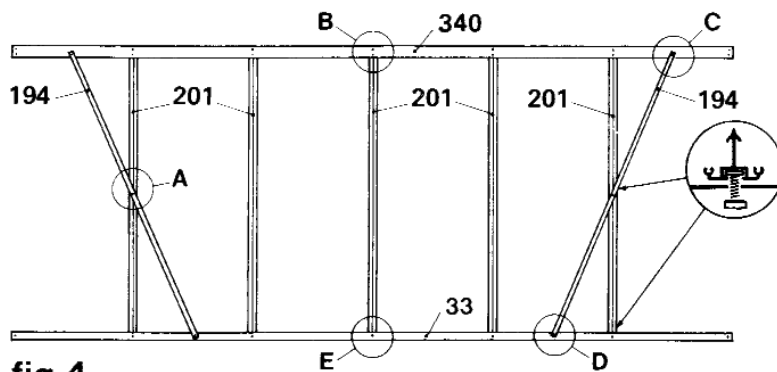

fig 4

126

2. Sides

Lay the parts coded in **fig. 4** on the ground. All the illustrations in this section are viewed from the inside. Join the sill bar (**701/01/33**) to the eaves bar (**843/353/340**) with the intermediate vertical bars (**201**) – see details **B** and **E**.

IMPORTANT

Remember to slide one bolt into the groove of each intermediate vertical bar that is crossed by a diagonal brace, in order to fix the centre of that brace, as in **A**.

The parts should be bolted with the square headed aluminium bolts and nuts provided, **but none of the bolts should be fully tightened until the greenhouse is completely assembled.**

Bolt the two diagonal struts (**194**) over the top, as in **A, C** and **D**.

Repeat with the other side.

3

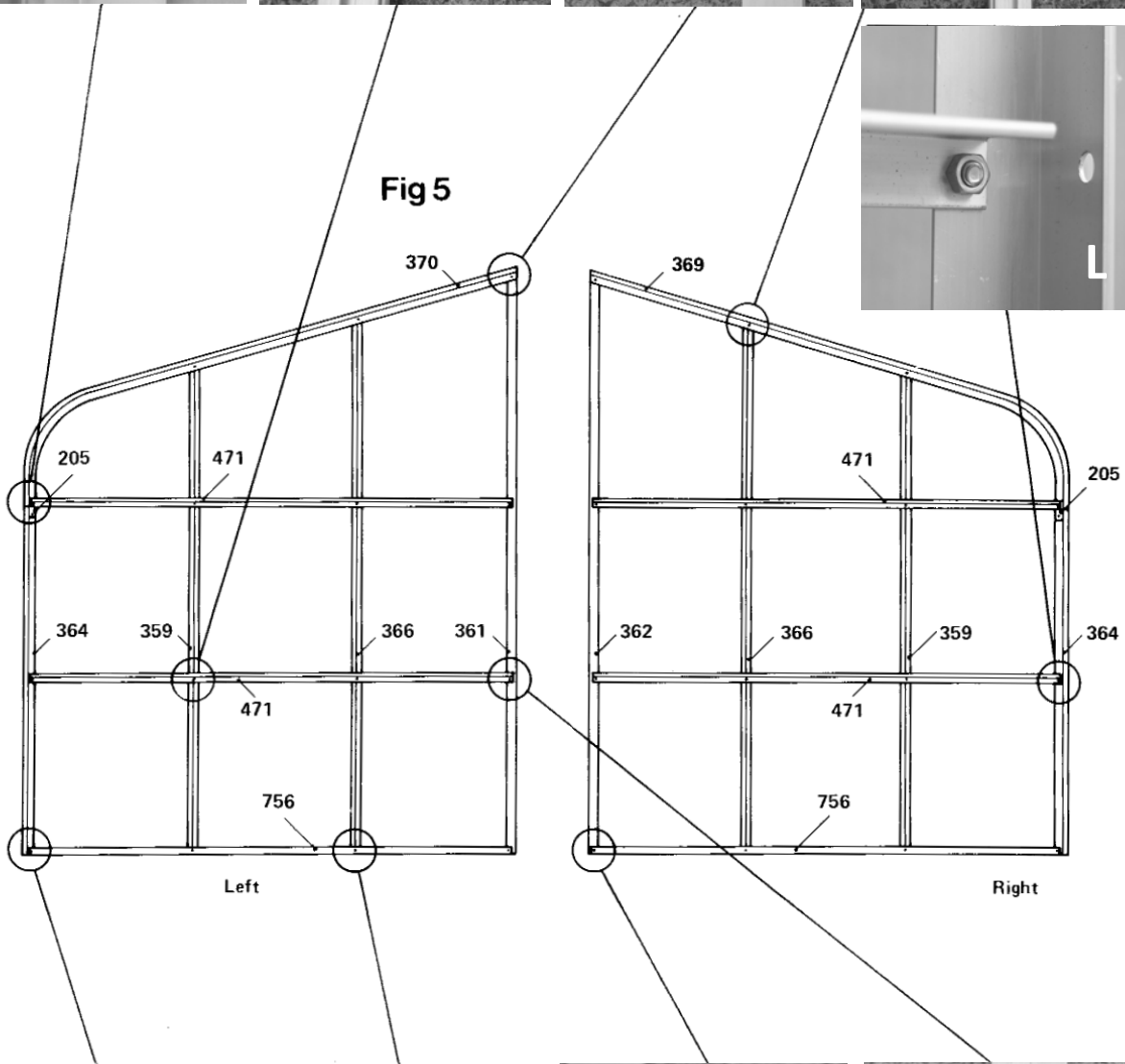
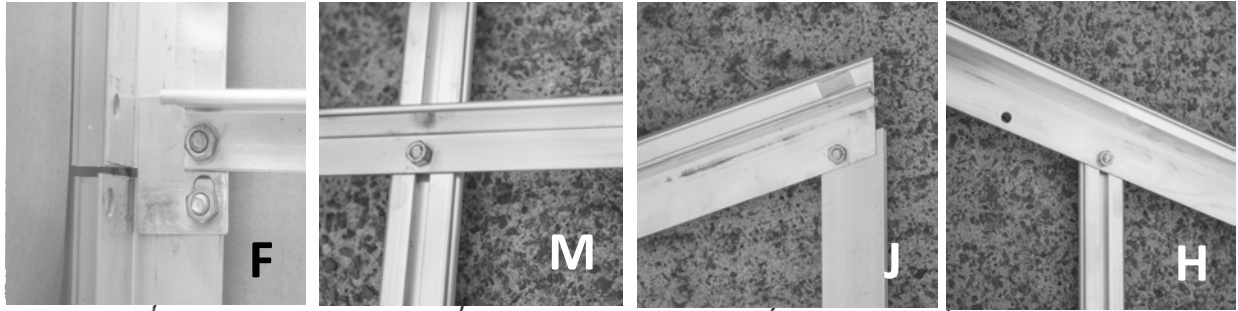

3. Plain Gable End

Note that the illustrations and photos are viewed from the inside. Left and right hand are decided by standing outside the greenhouse.

The door can go on either end. Choose on which end the door should be, and this will determine whether you build the left or right plain gable end.

Lay out the coded parts as before. Attach the corner plate (**205**) to the gable end bar (**369** or **370**) and the corner post (**364**) as in **F**.

Note that the plain side of the corner post should face inside the greenhouse and the bolt head on the outside.

Bolt the end sill bar (**756**) to the corner post (**364**) as in **G**. Fix the plain end vertical glazing bars (**359** or **366**) to the gable bar as in **H** and slide two bolts for the horizontal strut into each vertical bar before fixing the other ends to the sill bar as in **I**.

Attach the vertical wall bar (**361** or **362**) to the gable bar and the sill as in **J** and **K**. Bolt the horizontal bars (**471**) to the bolt in the corner post and the loose bolts in the vertical bars (**359** or **366**) as in **F** and **M** and bolt to the vertical wall bar **N**.

4

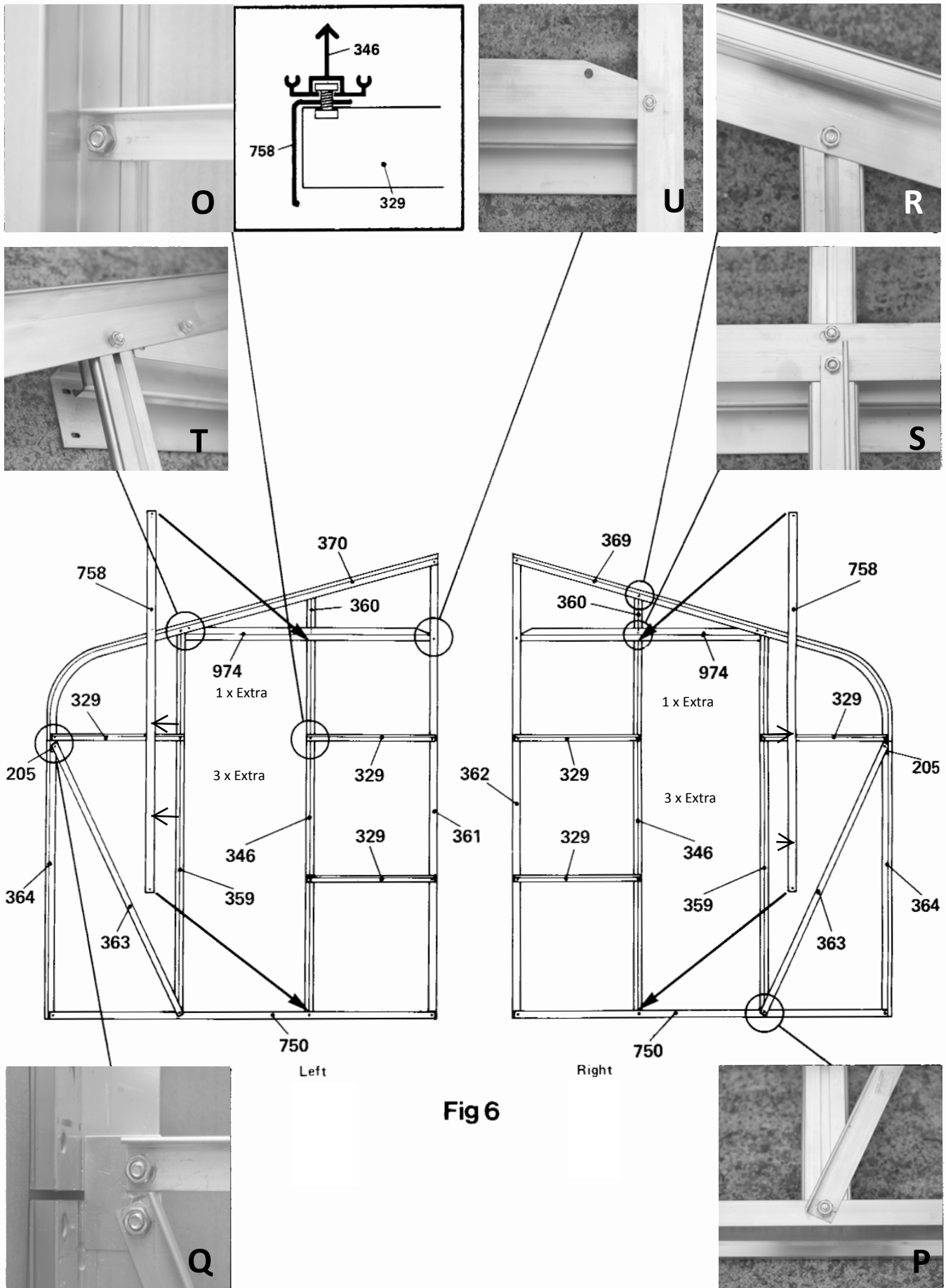

4. Door Gable End

Lay out the coded parts as before and bolt them together loosely using short bolts (400) in the same order as the plain gable end, except that the door track (974) should be fitted BEFORE the vertical bar (346) as in **T**, **S** and **U**.

Slide 2 bolts into (346) to attach the horizontal (329) and vertical stiffener (758) as in **O**. Match holes in stiffener (758) with holes in vertical wall bar (346) so that the stiffener is the correct way up.

Slide 4 bolts into vertical bar (359) to attach horizontal bar (329) and later the door jamb (757).

The door lock, if required, can only be fitted on the INSIDE of the greenhouse.

Note that the diagonal strut (363) is fixed to the sill bar (750) with the same bolt as the vertical bars as in **P** and fix the other end as in **Q**.

Loosely fit a nut and bolt into the middle of the door track and then slide small vertical bar (360) over the bolt head and tighten as in **S**.

Fix the other end of the vertical bar to the gable end in the same way as in **R**.

5

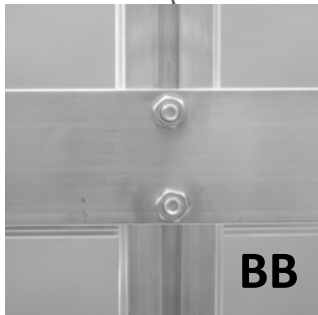
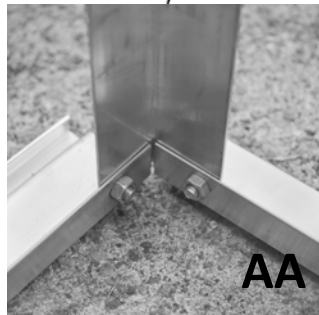
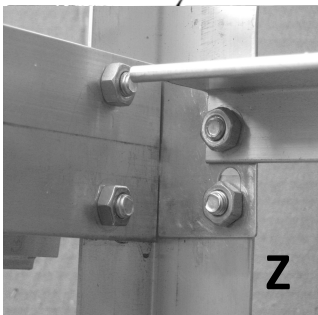
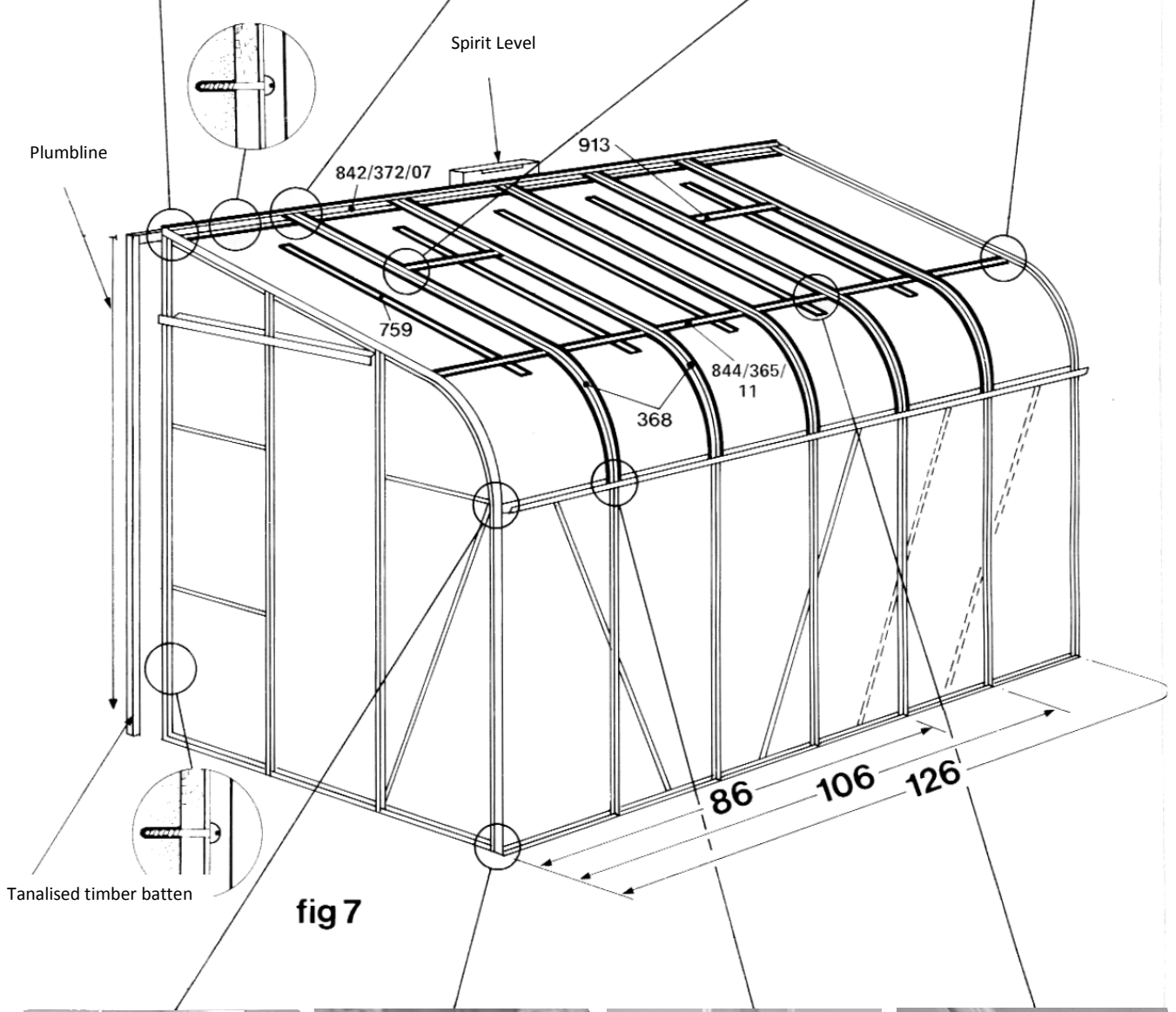
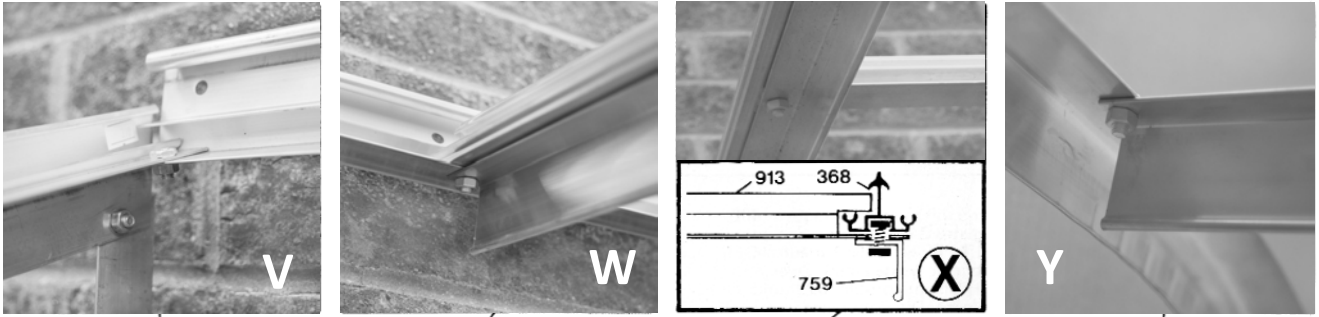

5. Assembly

Note that all the photos and illustrations in this section are viewed from the inside, except **fig. 7**.

Join the two ends to the side section as in **Z** and **AA**. If you find that the corner plates are too rigid, slacken off the bolts to allow more movement.

Mount the ridge bar (**842** or **372** or **07**) under the gable bars as in **V**. Fix ends of roof brace (**844** or **365** or **11**) to gable ends as in **Y**. Attach the curved intermediate roof bars (**368**) as in **W**. Note that picture **W** also has the roof stiffener attached.

The roof vent sills can only be positioned between two curved intermediate roof bars and should be fixed loosely into place as in **X**. To slide the sill bars into place, first insert a bolt at either end of the sills with the bolt heads uppermost. Then slide roof vent sill (**913**) very carefully into position from the bottom of the intermediate roof bars, inserting the two bolts at either end of the sill into the grooves of the bars. Ease into position detail **X**.

Before securing the intermediate roof bars (**368**) slide up **THREE BOLTS** in each to fit roof brace (**844** or **365** or **11**), roof stiffener (**759**) and to attach the bottom of (**368**) intermediate roof bars to the gutter.

Then use the bottom bolt in each intermediate glazing bar (**368**) to attach to the gutter. Then use the next spare bolt to secure roof brace (**844** or **365** or **11**).

Now fit stiffeners (**759**) picking up spare bolts in intermediate roof bars, roof braces (**844** or **365** or **11**) as in **CC** and roof vent sill, fixing the top to the bolt in the intermediate glazing bar (**368**).

Lift the frame onto the prepared base. Drop a plumbline from the top of the greenhouse to make sure that the ends are perfectly vertical and parallel to the plumbline.

Lightly secure it with a masonry pin (not supplied) driven halfway through one of the securing holes at the top. Mark the other fifteen or sixteen or seventeen (depending on size of greenhouse) securing holes on the wall and remove the frame and the masonry pin.

Drill the holes with a no. 10 bit, and plug with no. 10 wall plugs.

At this stage, a 12mm deep bead of mastic (not supplied) should be thoroughly applied between base and sill.

Replace the frame onto the base.

At this stage a 19mm x 16mm tanalised timber batten (not supplied) should be fitted between greenhouse and wall **fig. 7**.

Carefully drill securing holes through the timber batten and screw frame to wall. See detail in **fig. 7**.

Finally, secure the frame to the base. If you have a prefabricated base (which can be bought as an optional extra), follow the instructions that came with the base. If for any reason they are missing, you can find them on our website www.hallsgreenhouses.com on the Help and Advice tab where it says "Base Instructions".

If you have made your own base, you will need to drill through the sill of the greenhouse as in Section 1, **fig. 2a**. A perfect seal between the timber batten and wall may be obtained by using a mastic or foam sealing tape (not supplied).

IMPORTANT

Before finally tightening up all bolts, it is recommended that the sill, eaves, ridge and corner joints are sealed using the silicon sealant (**37**) supplied.

This is achieved by releasing one joint at a time to ensure the silicon sealant penetrates each joint.

Finally, go round and tighten all nuts and bolts, but be careful not to tighten so firmly that you break the threads on the bolts.

6a

N.B. Build the door before glazing.

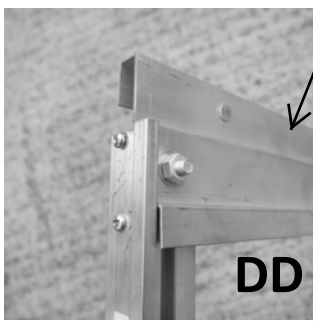

98

98

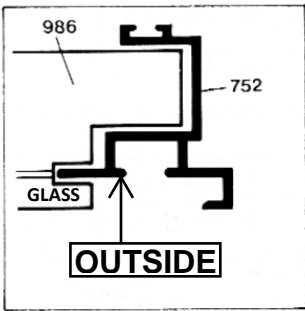
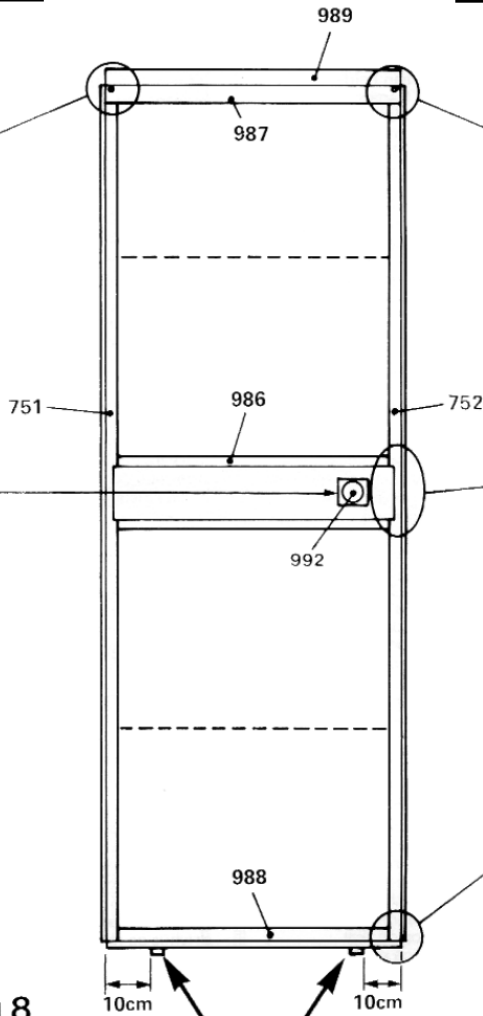
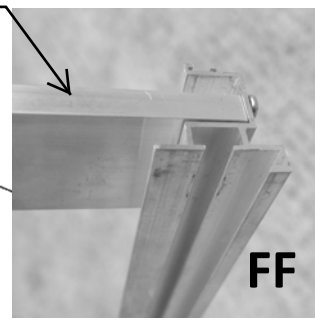
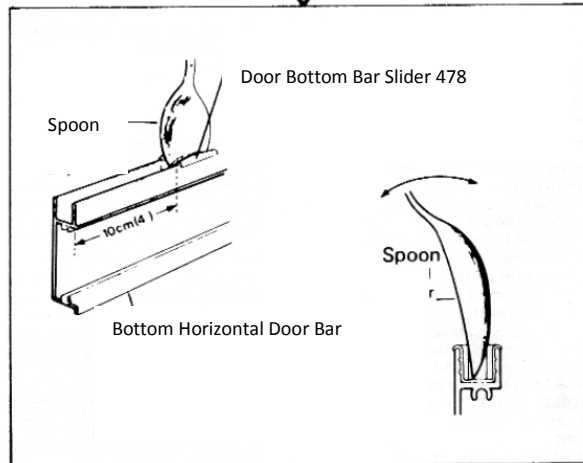

Fig 8



6a. Door

Lay the parts coded in **fig. 8** on the ground and attach the vertical door bars (**751** and **752**) to the top door bar (**987**) using the No. 6 x 16mm self-tapping screws (**1106**) provided as in **FF**. It is much easier to use an electric drill for this, making sure the torque setting is correct, i.e. the lowest setting.

Make sure the holes between the bottom door bar and the intermediate bar are further apart than the top in order to fit the shorter top glass pane **B**. This can be seen by laying the two vertical door bars side by side to match the holes.

Before fitting the intermediate door bar (**986**) check which side the door pull should be on, depending on whether your door is on the left side or right side of the greenhouse. For instance, if your door is on the right, the door pull should be on the left.

Fit the intermediate door bar (**986**) and the bottom door bar (**988**) as in **GG** and **HH**.

Fit the wheel-housing (**989**) to the top of the vertical door bars as in **DD**.

Fit the door bottom bar sliders (**478**) making sure the ears clip over the door bar, using a spoon if necessary (to fit fully home) as in **fig. 8**.

Stick flush door pulls (**992**) into the holes in both sides of the intermediate door bar as in **EE**.

6b

TOUGHENED

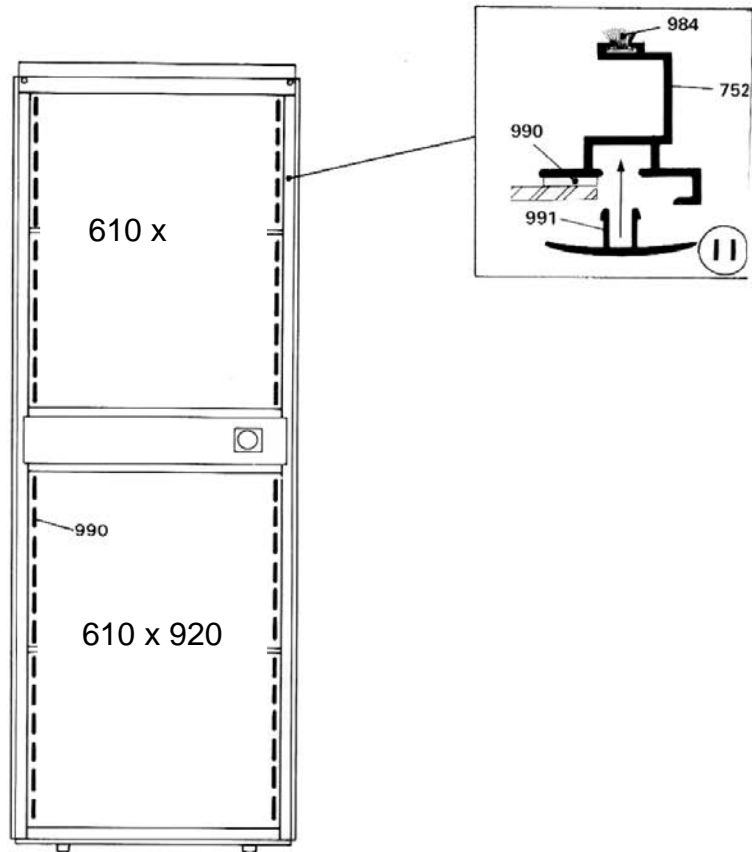

Fig 9

- Double sided adhesive foam strip 990
- Schaumstreifen mit doppelseitigem Kleber 990
- Ruban mousse 990
- Schuimband 990
- Skumrensa 990
- Skumstrimmel 990
- Tetningslist av skumplast 990

Door glazing

Remember glass is fragile, handle with care using gloves. Stick double-sided adhesive foam strip (990) to both vertical door bars as in II, making sure the aluminium surface is clean and dry.

Place the bottom pane of glass in position, making sure it is absolutely central.

Peel off the backing tape from foam strip up the vertical door bar only as far as the height of the pane of glass. Making sure glass is square, push onto foam strip.

Then repeat for the top pane, noting that the top pane is shorter. Wheel housing can be eased up to allow the glass to fit.

Clip door glazing cap (991) into both vertical door bars as in II.

With the door flat on the ground or on a bench, starting at the bottom, push down fairly hard with the heel of your hand working your way to the top, virtually flattening the capping (991) it will clip into both vertical door bars as in II.

Cut the top off level with the top of the glass with a hack saw. Then re-fit the door wheel housing. Slide door seal (984) into both vertical door bars as in II and crimp bottom end of door bars with pliers to prevent seal sliding down.

6c

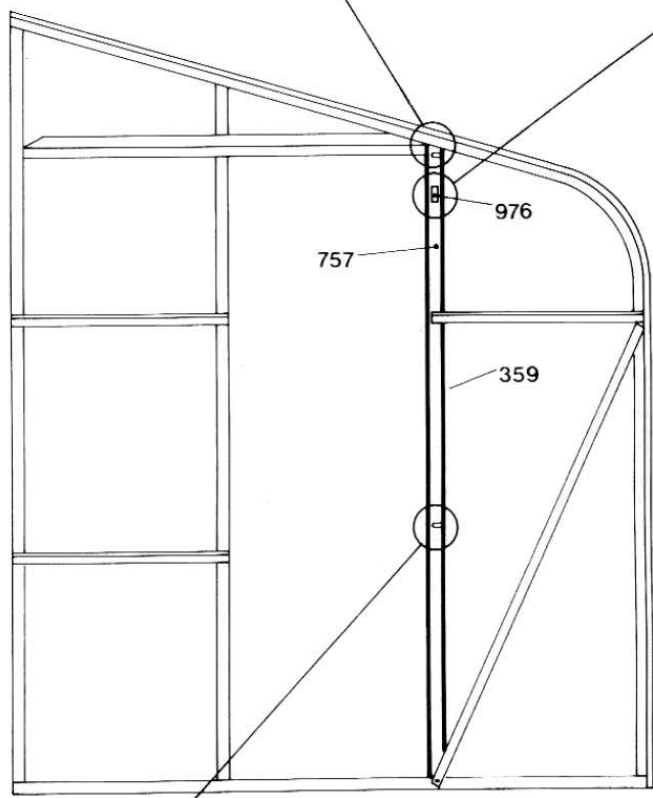
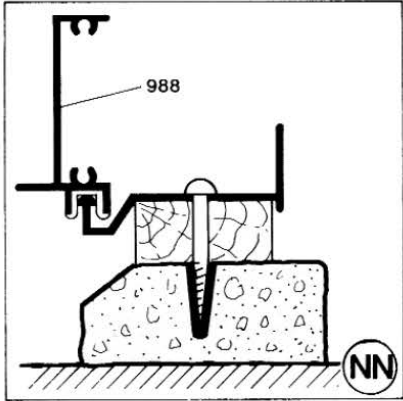

PLEASE NOTE THE DOOR LOCK IS ON THE INSIDE OF THE GREENHOUSE SO MAY NOT BE REQUIRED.

Door Gable End

Fig 10

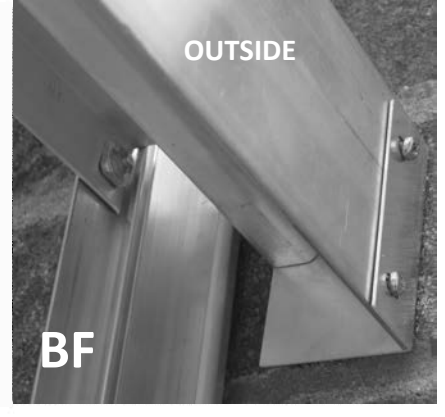
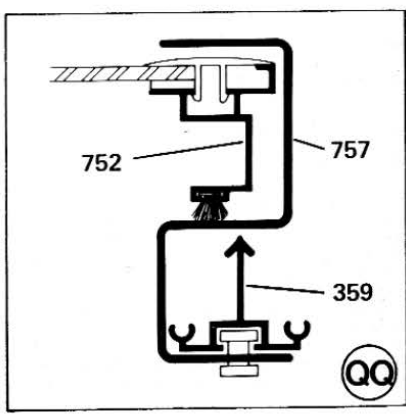

6c. Door Hanging

Slide the door onto the door track, making sure the bottom door bar fits over the sill, as in **NN**.

Adjust the bolts on the wheelhousing, so that the weight of the door is taken by the wheels, but ensuring that the bottom door bar fits over the sill, so that it acts as a guide, and that the vertical door bars do not catch on the track.

Tighten the bolts so that the door is held firmly and cannot wobble.

Note that the door lock is fitted on the **INSIDE** of the greenhouse so you may not need it. Fit door lock (**976**) to door jamb (**757**) with the two screws (**997**) through the holes provided in the door jamb as in **PP**.

Fit door jamb (**757**) to the door end vertical bar (**359**), noting the 2 small holes in end of the door jamb are at the top and using the four bolts already in place, line up bolts with slots in door jamb, push into place and tighten nuts as in **QQ** and **RR**.

Align the two holes in end of door track with the two holes on the top of the door jamb and bolt into place as in **OO** using screw (**996**).

Fit door track ends (**789**) as in **BF**.

7

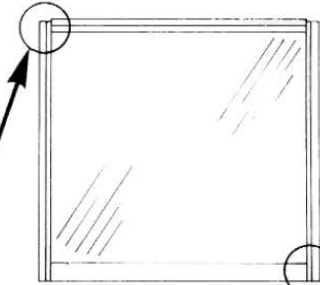
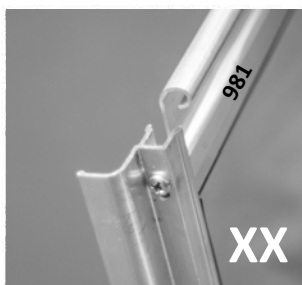
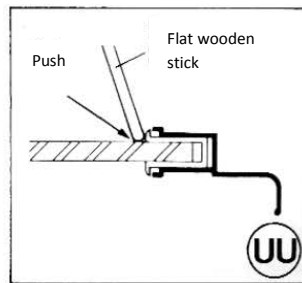
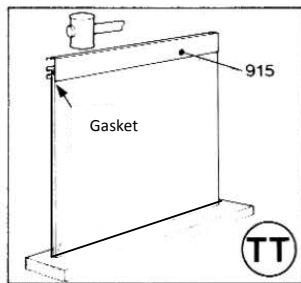
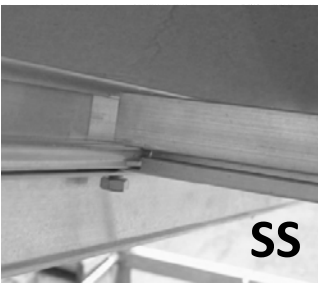
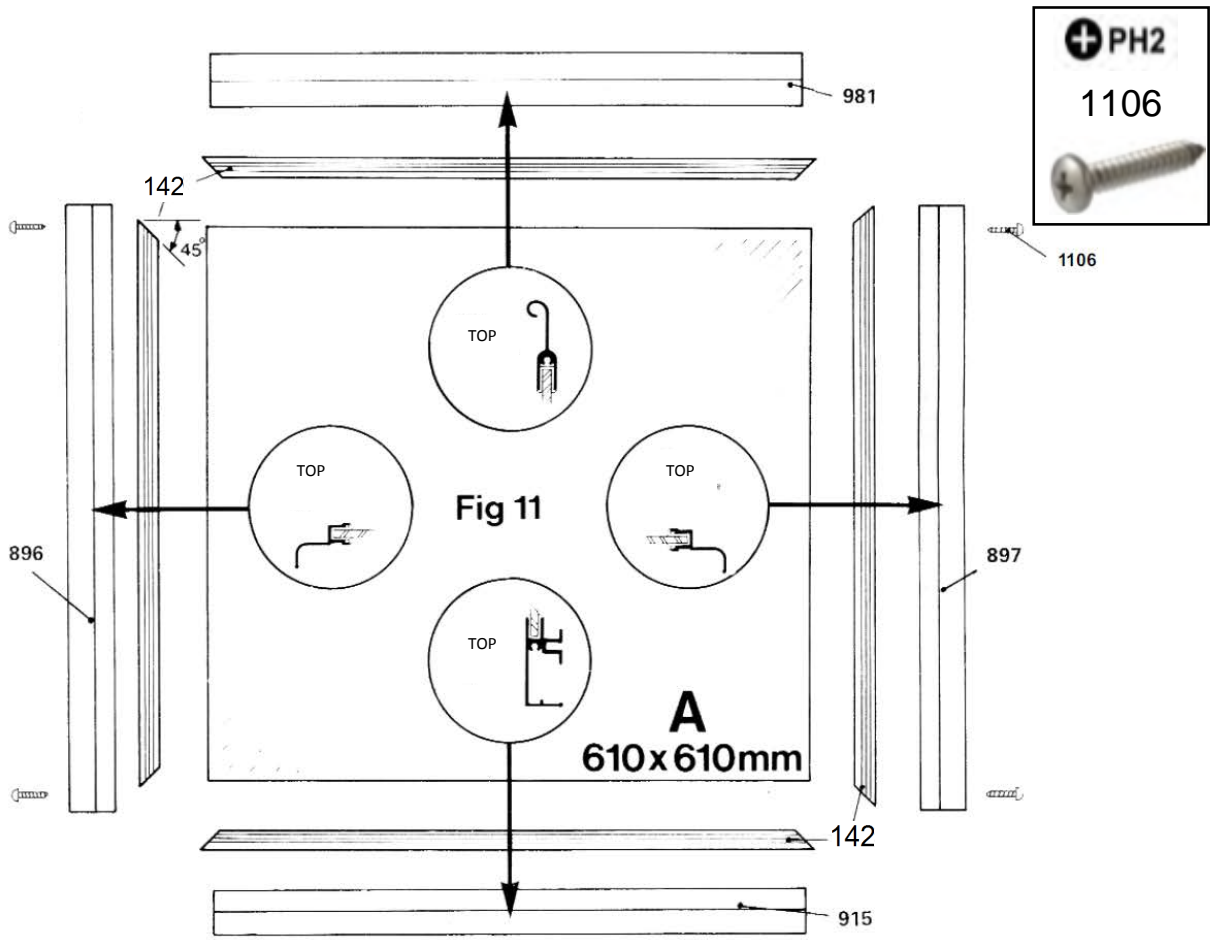

Completed vent from inside



Completed vent from outside

7. Roof Vent

The nuts holding the roof vent sill (**SS**) should be left loose for adjustment when fitting the roof vent.

Remember, glass is **FRAGILE!** Handle with care using gloves.

Working on a flat surface, cut four pieces of gasket (142) as in **fig. 11** so that the edges of the glass are completely covered by the gasket. Do not stretch. Cutting the gaskets slightly oversize will ensure a tight fit at the corners.

Place one length of gasket onto the bottom edge of the glass, fit vent bottom bar (**915**). Place centrally over the glass. Knock down with a wooden, rubber or hide mallet with the glass held vertical, supporting the free edge on a wooden block as in **TT**.

Repeat at the opposite glass edge with vent top bar (**981**) making sure the part is the correct way up.

Repeat the other two sides, making sure they are the correct way round, noting the hole nearest the end of the roof vent side bar is at the top nearest the ridge.

Apply a small amount of silicon sealant to each corner joint to seal join in gasket.

Assemble the corners of the frame by means of the four self-tapping screws (**1106**) as in **XX** and **YY**, straightening the bars if bowed.

Check the diagonal measurements for squareness. Adjust if necessary and tighten the screws.

Bed gaskets down onto frame on both sides of the glass using a flat wooden stick, as in **UU**. Slide the top bar of the roof vent into the mating portion at the end of the ridge bar and slide along ridge bar into position required as in **VV**.

If you have difficulty sliding the roof vent into place, the parts may be lubricated with a little petroleum jelly or grease.

Loosely fit the roof vent stay (**983**) to the approximate middle of the roof vent bar and the sill bar (picture **SS**) using self-tapping screws (**229**) as in **WW**.

Adjust roof vent sill bar with vent in closed position.

If the roof vent catches on the top of the glazing bar, the nut holding this bar may be slackened off and the glazing bar moved slightly.

Alternative glazing method for roof vent

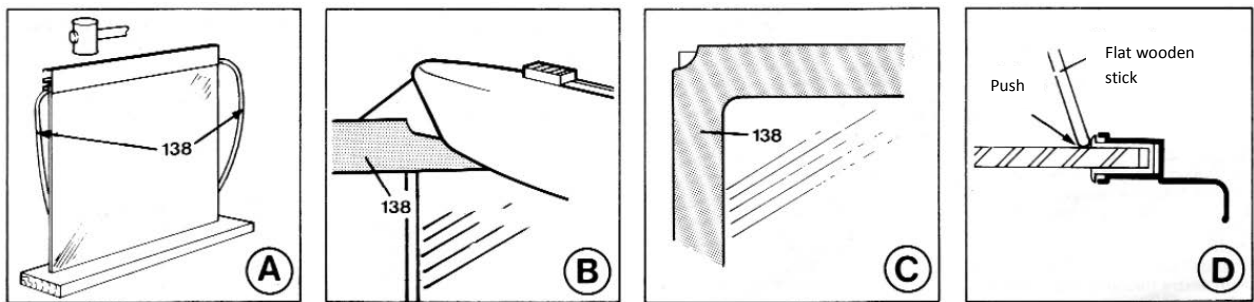
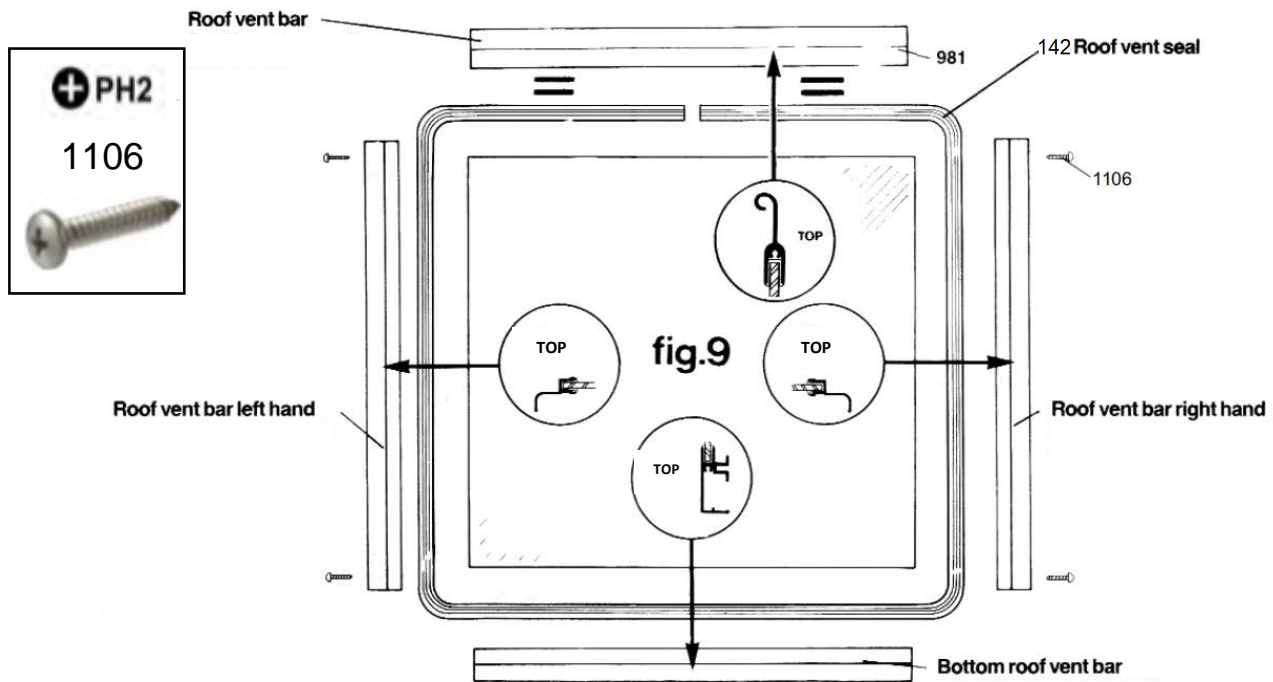

Warm up roof vent seal (142) to approximately room temperature.

Working on a flat surface, cap the bottom edge of glass with roof vent seal (142), being careful not to stretch seal. Fit roof vent bottom bar centrally over the glass, knock down gently with a wooden, rubber or hide mallet with the glass held vertically, supporting the free edge on a wooden block as in **A**.

REMEMBER, GLASS IS FRAGILE, HAND WITH CARE USING GLOVES.

Using a sharp knife, make a cut into the glazing seal, slightly back from the corner of the glass as in **B**.

Cap both sides of the glass with the seal, ensuring cut in seals fits over the corner of the glass as in **C**.

Fit left and right roof vent bars over the glass and fix corners to roof vent bottom bar using self-tapping screws (**1106**). Please see main instructions. Cut the seal slightly back from the corners as before and cap top edge of glass, cutting seal so that it butts together in the centre of the roof vent bar as in **fig. 9**.

Fit roof vent bar over glass and assemble corners using self-tapping screws (**1106**) as before.

Check diagonal measurements for squareness.

Adjust if necessary and tighten screws.

Bed gaskets down onto frame using a flat wooden stick as in **D**.

Apply small amount of silicone sealant (**37**) to each corner.

See main instructions for fitting of vent to building.

6b

HORTICULTURAL

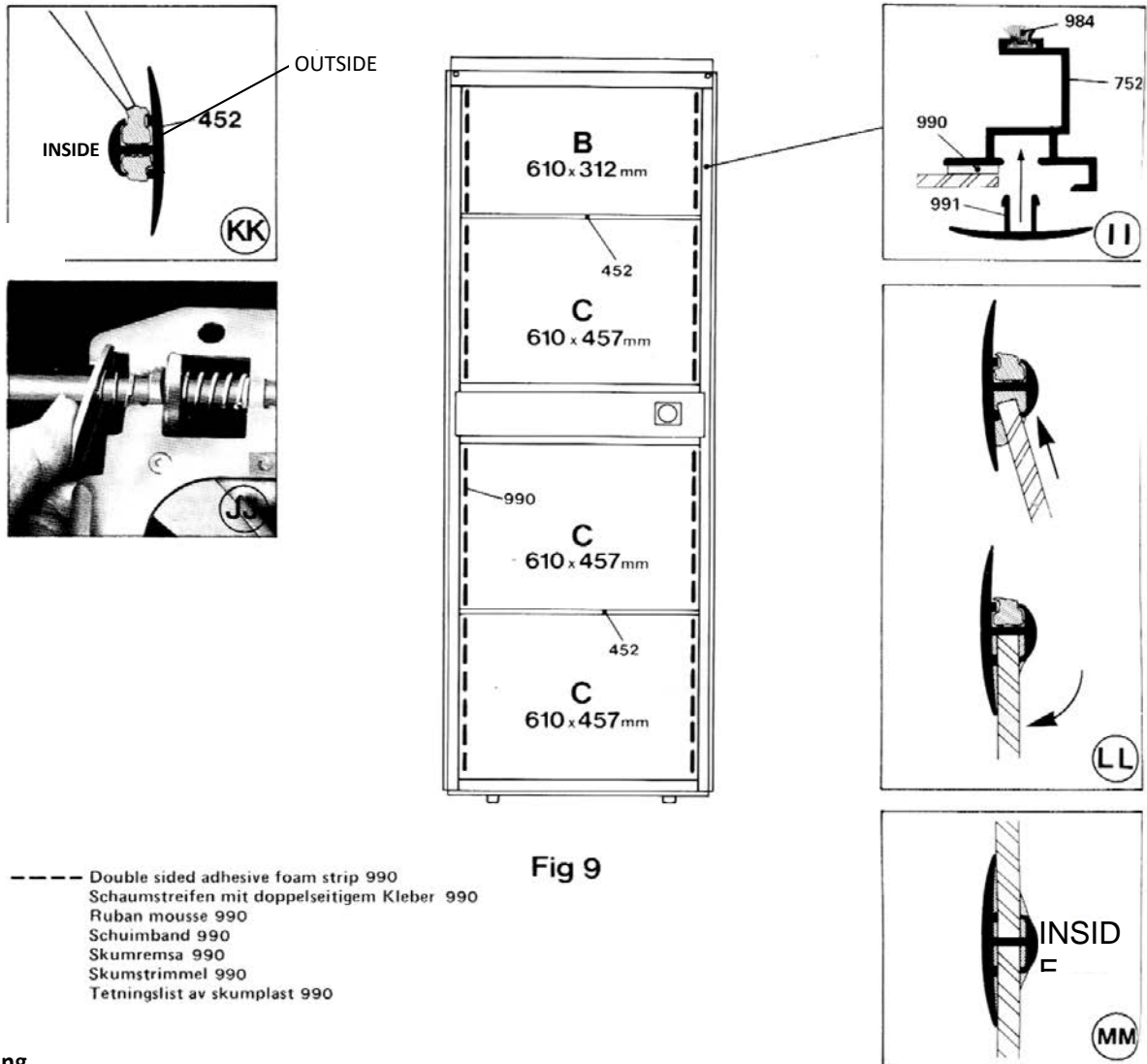

Door glazing

Remember glass is fragile, handle with care using gloves. Stick double-sided adhesive foam strip (990) to both vertical door bars as in II, making sure the aluminium surface is clean and dry.

The silicon sealant (37) is to be used to seal the joint between the glass and glazing retaining H (452) as in KK.

Starting at the bottom, apply sealant (37) to the H section and carefully push onto one pane of glass C with a rolling action as in LL, immediately wiping off excess with a clean dry cloth.

NOTE: Load silicon sealant cartridge into gun (supplied). It is important to back off the pressure after each application to prevent seepage of sealant when not in use. This can be achieved by pressing thumb catch on back of gun as in JJ.

To achieve a good seal, all surfaces must be clean, dry and free from oil which can be achieved by using white spirit.

Place the other end of the glass onto the bottom door bar. Peel off the backing tape from foam strip up the vertical door bar only as far as the height of the first pane of glass. Making sure glass is square, push onto foam strip.

Push the next pane of glass code C with a rolling action as in LL as far as possible into the H section on the first pane as in MM sealing as before. Peel off backing tape as before and push into position. Immediately wipe off excess sealant from glass using clean dry cloth.

Repeat glazing above intermediate door bar as before but notice that the top glass pane B is shorter. Wheel housing can be eased up to allow the glass to fit.

Clip door glazing cap (991) into both vertical door bars as in II. Slide door seal (984) into both vertical door bars as in II and crimp bottom end of door bars with pliers to prevent seal sliding down.

With the door flat on the ground or on a bench, starting at the bottom, push down fairly hard with the heel of your hand working your way to the top, virtually flattening the capping (991) it will clip into both vertical door bars as in II. Cut the top off level with the top of the glass with a hack saw. Then re-fit the door wheel housing. Slide door seal (984) into both vertical door bars as in II and crimp bottom end of door bars with pliers to prevent seal sliding down.

8

HORTICULTURAL GLAZING

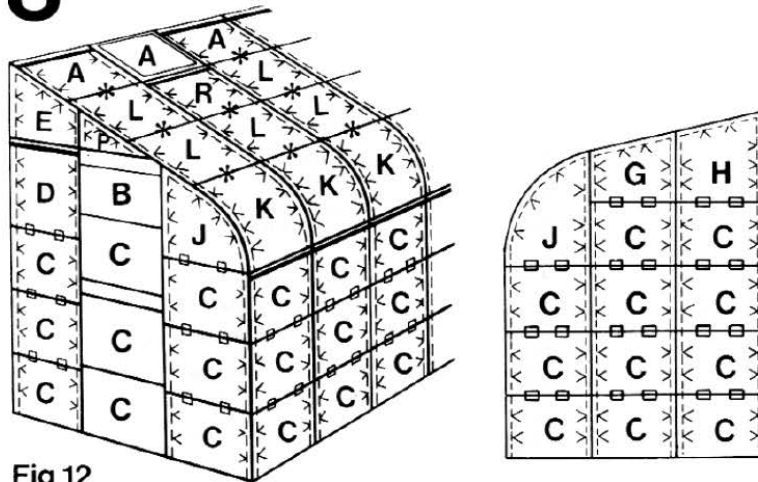
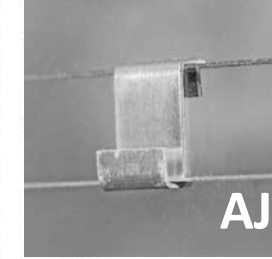
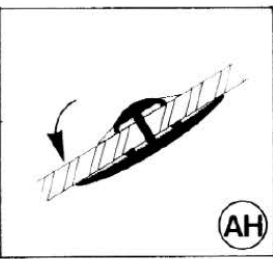
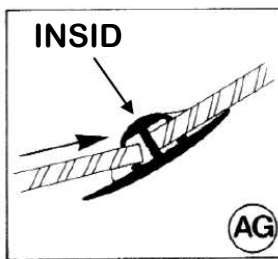
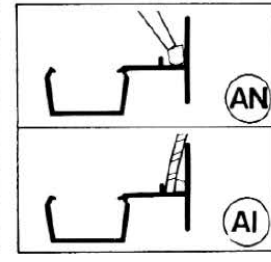
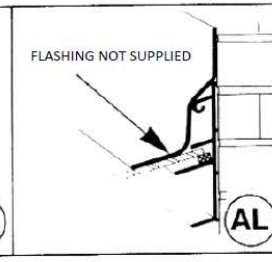
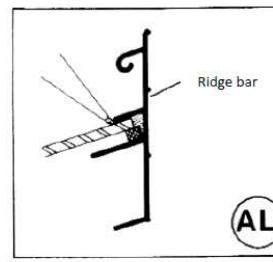
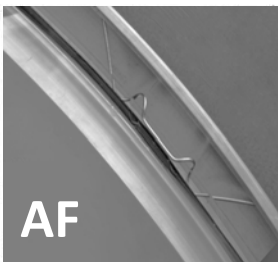
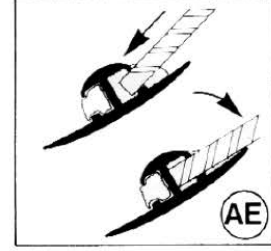
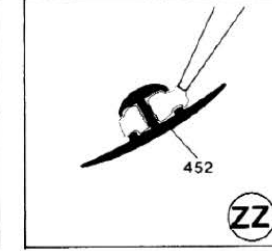
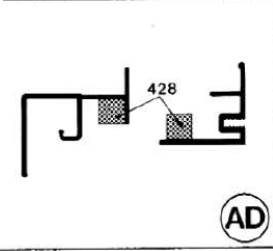
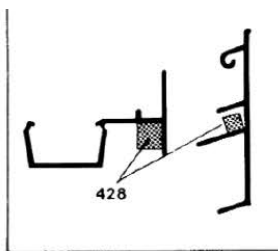
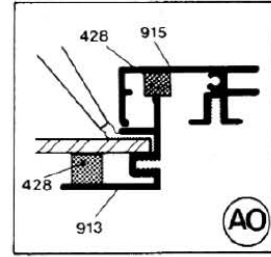
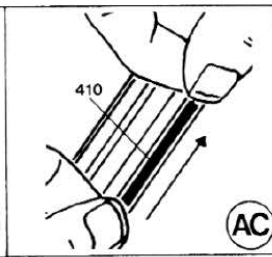
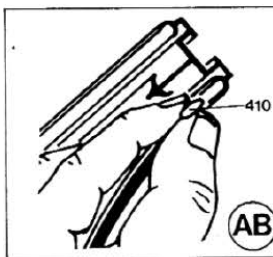

Fig 12

- 410 Glazing strip
- < 453 Glazing spring clips
- 458 Glass retaining clips
- 428 Self adhesive foam strips
- * 452 Glazing retaining "H"

Code	GLASS Size mm	86	106	126
A	610 x 610	4	5	6
B	610 x 305	1	1	1
C	610 x 457	32	35	38
D	610 x 540	1	1	1
E	610 x 399	1	1	1
P	610 x 200	1	1	1
G	610 x 308	1	1	1
H	610 x 507	1	1	1
J	610 x 556 (3mm Acrylic)	2	2	2
K	610 x 610 (2mm Acrylic)	4	5	6
L	610 x 508	7	8	10
R	610 x 467	1	2	2
TOTAL		56	63	70



8. Glazing for HORTICULTURAL GLASS

Remember, glass and plastic are fragile. **HANDLE WITH CARE** using gloves and store upright. First, fit the glazing strip (410). It is easier to insert glazing strip if it is at room temperature.

Starting at the top near the ridge bar, pinch the glazing strip between your forefinger and thumb, push it into the grooves in the glazing bar as in **AB**. Holding the inserted part of the strip with one hand, ease it along its length taking care not to stretch it as in **AC** and cut to length.

Before glazing the side and roof of your greenhouse, stick the self-adhesive foam strip (428) to the underside of the eaves bar, ridge bar, door track and roof vent sill bar as shown in **AD**.

Study the glazing pattern as in **fig. 12**.

BEFORE STARTING THE GLAZING, IT IS IMPORTANT TO CHECK THAT THE ROOF BARS ARE SQUARE WITH THE EAVES BARS.

The silicone sealant (37) is to be used to seal the joints between glass and glazing retaining **H** (452) as in **ZZ**. Note that the wide side of the retaining **H** is on the **INSIDE** of the greenhouse throughout (see **AG**) and that the sealant is applied generously into the bottom of both slots in the retaining **H**.

Starting with the roof, apply silicon sealant (37) into the **H** section (452) as in **ZZ** (remembering to back off gun after application). Carefully push **H** section onto one pane of glass code **A** immediately wiping off excess sealant with a clean dry cloth as in **AE**.

N.B. To achieve a good seal, all surfaces must be clean, dry and free from oil.

Push the other end of the glass as far as possible under the ridge bar and hold it in place with the glazing spring clips (453) as in **AF**.

IT IS RECOMMENDED THAT FLASHING OF SOME TYPE IS FITTED (NOT SUPPLIED) TO THE FULL LENGTH OF THE RIDGE BAR WITH ABOUT A 60mm OVERHANG EITHER END TO REDUCE POSSIBLE WATER INGRESS as in **AL**.

As an extra precaution, run a thin bead of silicon sealant along the top outside edge of each H section already in position immediately wiping off excess as before.

Fit another **H** section (452) to a pane of glass **L** carefully sealing as before and push the other end of the glass as far as possible into the **H** section on the first pane as in **AG** and rotate glass down onto glazing bar as in **AH** immediately wiping off as before.

As each joint is made, visually inspect along the join from the outside that a continuous film of sealant runs the complete width of each pane of glass.

Repeat for the next pane of glass **L**.

Apply sealant into lip on eaves bar as in **AN**.

Take plastic sheet code **K**, **removing protective film from both sides**, and push up into the **H** section sealing as before, then bend the sheet so the bottom edge fits behind the retaining lip on the top of the eaves bar as in **AI**.

Repeat to complete the roof.

If you have difficulty inserting the final pane, check that the upper panes have not slipped down. Should there be a gap at the bottom, the panes may be lowered, provided the top pane remains under the capping provided by the ridge.

To finish glazing the greenhouse start from the bottom placing a pane of glass on the sill and fix with spring clips. Place two retaining clips (458) on the top edge of the glass. Place the next pane into retaining clips with the bottom edge outside, as in **AJ**. Fit the rest of the glass in the greenhouse following the same method. Glaze the corners as in **AK**.

Check List

1. Door is sliding smoothly, adjust if necessary.
2. Roof vent is opening and closing smoothly.
3. Check all nuts and bolts are secure.
4. Check that all the corner joints are sealed, particularly in the roof vent area, and inside corner of sill, eaves and ridge.

8

LONG PANE TOUGHENED GLASS

Apart from the door, the glass and acrylic are held in with "W" spring clips as with horti.

Remember, glass and plastic are fragile. **HANDLE WITH CARE** using gloves and store upright.

First, fit the glazing strip (**410**). It is easier to insert glazing strip if it is at room temperature.

Starting at the top near the ridge bar, pinch the glazing strip between your forefinger and thumb, push it into the grooves in the glazing bar as in **AB** (see horticultural glass page). Holding the inserted part of the strip with one hand, ease it along its length taking care not to stretch it is as in **AC** and cut to length. There is no easy way to do this!

) o below

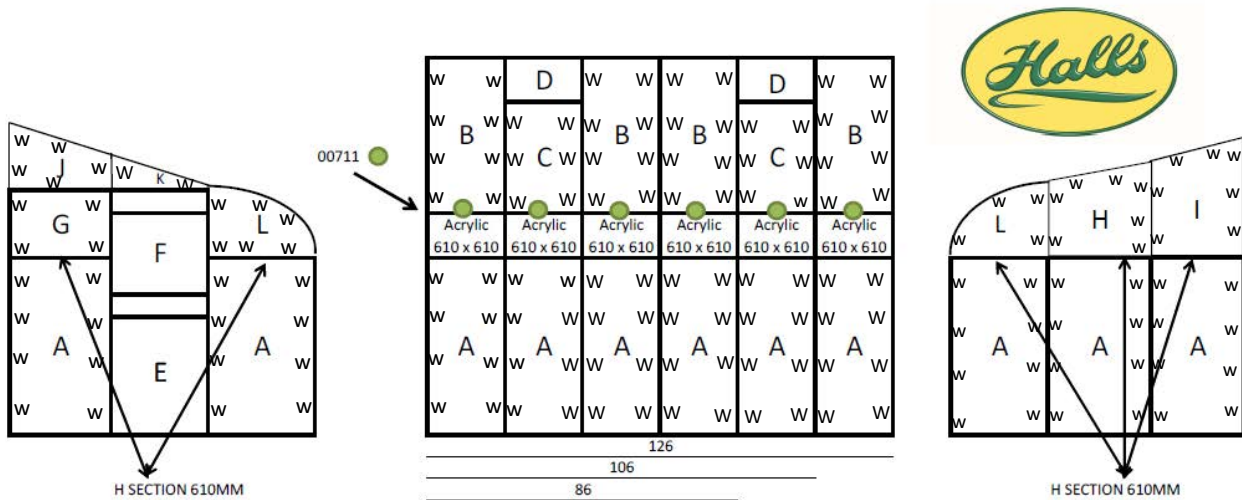

			86	106	126
A	GLT 4005	610 X 1347	9	10	11
B	20006	610 X 1660	3	3	4
C	20007	610 X 995	1	2	2
D	10032	610 X 610	1	2	2
E	20008	610 X 920	1	1	1
F	20009	610 X 765	1	1	1
G	20010	610 X 526	1	1	1
H	20011	610 X 738 X 548	1	1	1
I	20012	610 X 930 X 742	1	1	1
J	10999	610 X 399 X 205	1	1	1
K	20000	610 X 200 X 6	1	1	1
L	20013	610 X 535 CURVED	2	2	2
	12467	H SECTION 610MM	5	5	5
	00711	Z SECTION 610MM	4	5	6

GLAZING PLAN FOR CURVED LEAN TO

8 X 6, 10 X 6, 12 X 6

BEFORE STARTING THE GLAZING, IT IS IMPORTANT TO CHECK THAT THE ROOF BARS ARE SQUARE WITH THE EAVES BARS.

Push the top end of the glass as far as possible under the ridge bar and hold it in place with the glazing spring clips (**453**) as in **AF**.

IT IS RECOMMENDED THAT FLASHING OF SOME TYPE IS FITTED (NOT SUPPLIED) TO THE FULL LENGTH OF THE RIDGE BAR WITH ABOUT A 60mm OVERHANG EITHER END TO REDUCE POSSIBLE WATER INGRESS as in **AL**.

Apply sealant into lip on eaves bar as in **AN**.

Fit plastic "Z" section, part 711 (widest part for glass) to the bottom of the pane, making sure it is pushed as far onto the glass as it will go. Take plastic sheet code **K**, **removing protective film from both sides**, and push up into the **Z** section as far in as it can go, underlapping the glass pane above. Then bend the sheet so the bottom edge fits behind the retaining lip on the top of the eaves bar as in **AI**. Secure with "W" spring clips.

To finish glazing the greenhouse start from the bottom placing a pane of glass on the sill and fix with spring clips.

Check List

1. Door is sliding smoothly, adjust if necessary.
2. Roof vent is opening and closing smoothly.
3. Check all nuts and bolts are secure.
4. Check that all the corner joints are sealed, particularly in the roof vent area, and inside corner of sill, eaves and ridge.



Halls
Greenhouses

www.hallsgreenhouses.com

This product is delivered by a company in the Juliana Group - www.juliana.com